

SIEMENS



Betagard – Inspiring Safety

Answers for infrastructure.

Overview

The resistance of a human body to current depends on the current path. Measurements have shown that, a current path of hand/hand or hand/foot has a resistance of approx. 1000Ω , taking into account a fault voltage of 230V AC, this produces a current of 230mA for the current path hand/hand.

Three function groups largely determine the setup of residual current protective devices:

- a. Summation current transformers for fault current detection
- b. Releases to convert the electrical measured quantities into a mechanical tripping operation
- c. Breaker mechanism with contacts

The summation current transformer covers all conductors required to conduct the current, i.e. also the neutral conductor where applicable.

In a fault free system, the magnetizing effects of the conductors through which current is flowing cancel each other out for the summation current transformer, as the sum of all currents is zero. There is no residual magnetic field left that could induce a voltage in the secondary winding. However, by contrast, if a residual current is flowing due to an isolation fault, this destroys the equilibrium and a residual magnetic field is left in the core of the converter. This generates a voltage in the secondary winding, which then uses the release and the breaker mechanism to switch off the electrical circuit afflicted with the isolation fault. This tripping principle operates independently of the system voltage or an auxiliary power supply. This way it can be ensured that the full protective action of the residual current protective device is maintained even in the event of a system fault.

Due to the use of electronic components in household appliances and industrial plants, insulation faults can also cause residual currents that are not AC residual currents to flow through residual current protective devices, even in the case of devices with ground terminals.

The basic prerequisite for use of a residual current protective device is the running of a grounded PE conductor to the components and equipment to be protected. A current flow can then pass through a human body only when two faults occur (1) Interruption of the PE conductor in addition to the insulation fault or (2) When there is unintentional contact with live parts.

Residual current protective devices offer protection against

1. Direct contact – Direct contact is considered as direct contact of a human body with a live part.
2. Indirect contact (fault protection) – Indirect contact is considered as the contact of a human body with a de-energized, electrically conductive part. In these cases, the demand is for automatic interruption of the power supply when a fault can pose a risk due to the intensity and duration of the touch voltage.

3. Fire protection – For locations exposed to fire hazards, residual current protective devices should offer earth leakage protection for the prevention of fires, which may originate from insulation faults.

Types of residual current protective devices

1. Type AC – Residual current protective devices of type AC are suitable only for detecting sinusoidal AC residual currents.
2. Type A – In addition to AC sinusoidal currents, residual current protective devices of type A also measure pulsating DC residual currents. e.g. applications like ECGs, washing machines, fax machines etc. having electronic components.

Betagard RCBOs have the unique distinction of combining the earth leakage protection function of an RCCB with the overload and short circuit function of MCB.

Betagard RCBO (2P, 2M) is available from 6 to 40A in 1Pole+Neutral version. The device has a breaking capacity of 10kA as per IEC60898 and is available in 2 Module width size.

This RCBO can be used for personnel as well as fire protection:

- $I_{\Delta n} \leq 30\text{mA}$: Additional protection in the case of direct contact
- $I_{\Delta n} \leq 300\text{mA}$: Preventive fire protection in the case of ground fault currents

Betagard RCBOs are also offered combination devices, which offer overcurrent protection for overload and short circuit protection in addition to protection against residual currents. A version in this device group is a residual current block (RC unit) combined to a miniature circuit breaker (selected on the basis of characteristic & rated current) to form a RCBO. These devices are factory assembled and offer the same functions as RCBO. The RC unit has no contacts of its own; in the event of a fault, it trips the circuit breaker, which opens the contacts and interrupts the circuit.

Betagard RCBOs are available in 4 standard versions from 32A to 63A. They offer 10kA-breaking capacity as per IS8828 in 2P and 4P versions.

1. MCB C characteristics with RC unit Type AC
2. MCB C characteristics with RC unit Type A
3. MCB D characteristics with RC unit Type AC
4. MCB D characteristics with RC unit Type A

Betagard Residual Current Devices

Betagard 5SU RCBOs

Technical specifications

Technical specifications (5SU1 RCBOs)

Standards	IS 12640-2 (2008), IEC 61009, VDE 0664 Part 20/Part 30, IEC 61543
No. of Poles	1Pole + N, 2P, 4P
Rated voltages, Un (V)	125...240V AC, 50...60Hz; 240V / 415 V AC 50...60Hz
Rated currents, In (A)	6, 10, 16, 20, 25, 32, 40, 63
Rated residual currents (mA)	30, 100, 300
Rated short circuit capacity (kA)	10
Tripping characteristics	C, D
Energy limiting class	3
Enclosure	Gray molded plastic (RAL 7035)
Mounting depth (mm)	70
Terminals	
1. Conductor cross section (sqmm)	1... 25
2. Terminal tightening torque (Nm)	2.5... 3
Supply connection	Either top or bottom
Mounting position	Any
Mounting technique	Can be snapped on to a 35mm DIN rail
Degree of protection	IP20 acc to EN60529 (VDE 0470 Part 1) IP40/IP42 for installation in distribution boards
Minimum operating voltage for test function operation (V)	195V AC
Device service life	> 10,000 operations (electrical and mechanical)
Storage temperature (°C)	-40... +75
Ambient temperature (°C)	-25... +45
CFC and silicon free	Yes

Betagard Residual Current Devices

Betagard 5SU RCBOs

Product Overview

Betagard Residual Current Breaker Operators - 5SU1, 10kA

Un 240Vac, 50...60Hz

Product Standards: IS 12640, Part 2/IEC 61009-1

With ISI marking : CM/L No. 7676193



Type AC, applicable in networks for AC residual currents

	Rated residual current I_n (mA)	Rated current I_n (A)	MW#	Reference No.	Std. Pkg. (Nos.)	
	1 pole + N	30	6	2	5SU13541RC06	1/10
		30	10		5SU13541RC10	1/10
		30	16		5SU13541RC16	1/10
		30	20		5SU13541RC20	1/10
		30	25		■ 5SU13541RC25	1/10
		30	32		■ 5SU13541RC32	1/10
		30	40		■ 5SU13541RC40	1/10
		300	6		5SU16541RC06	1/10
		300	10		5SU16541RC10	1/10
		300	16		5SU16541RC16	1/10
		300	20		5SU16541RC20	1/10
		300	25		5SU16541RC25	1/10
		300	32		5SU16541RC32	1/10
		300	40		5SU16541RC40	1/10

Type A, applicable in networks with AC residual currents and/or pulsating DC currents

	Rated residual current I_n (mA)	Rated current I_n (A)	MW#	Reference No.	Std. Pkg. (Nos.)	
	1 pole + N	30	6	2	5SU13547RC06	1/10
		30	10		5SU13547RC10	1/10
		30	16		5SU13547RC16	1/10
		30	20		5SU13547RC20	1/10
		30	25		5SU13547RC25	1/10
		30	32		5SU13547RC32	1/10
		30	40		5SU13547RC40	1/10
		300	6		5SU16547RC06	1/10
		300	10		5SU16547RC10	1/10
		300	16		5SU16547RC16	1/10
		300	20		5SU16547RC20	1/10
		300	25		5SU16547RC25	1/10
		300	32		5SU16547RC32	1/10
		300	40		5SU16547RC40	1/10

Type AC with C characteristic

	Rated residual current $I_{\Delta n}$ (mA)	Rated current I_n (A)	MW#	Reference No.	Std. Pkg. (Nos.)		
	240Vac; 50...60Hz; 2 pole	30	4	5SU13241RC32	1/10		
				5SU13241RC40	1/10		
				5SU13241RC63	1/10		
		100	4	5SU14241RC32	1/10		
				5SU14241RC40	1/10		
				5SU14241RC63	1/10		
		300	4	5SU16241RC32	1/10		
				5SU16241RC40	1/10		
				5SU16241RC63	1/10		
			415Vac; 50...60Hz; 4 pole	30	7	5SU13441RC32	1/5
						5SU13441RC40	1/5
						5SU13441RC63	1/5
100	7			5SU14441RC32	1/5		
				5SU14441RC40	1/5		
				5SU14441RC63	1/5		
300	7			5SU16441RC32	1/5		
				5SU16441RC40	1/5		
				5SU16441RC63	1/5		



Note: ■ Stock Items # 1MW (Module Width) – 18mm

Betagard Residual Current Devices



Betagard 5SU RCBOs

Product Overview



Type AC with D characteristic

	Rated residual current $I_{\Delta n}$ (mA)	Rated current I_n (A)	MW#	Reference No.	Std. Pkg. (Nos.)				
	240Vac; 50...60Hz; 2 pole		4	5SU13242RC32 5SU13242RC40 5SU13242RC63 5SU14242RC32 5SU14242RC40 5SU14242RC63 5SU16242RC32 5SU16242RC40 5SU16242RC63	1/10 1/10 1/10 1/10 1/10 1/10 1/10 1/10 1/10				
	30	32 40 63							
	100	32 40 63							
	300	32 40 63							
		415Vac; 50...60Hz; 4 pole				7	5SU13442RC32 5SU13442RC40 5SU13442RC63 5SU14442RC32 5SU14442RC40 5SU14442RC63 5SU16442RC32 5SU16442RC40 5SU16442RC63	1/5 1/5 1/5 1/5 1/5 1/5 1/5 1/5 1/5	
		30							32 40 63
		100							32 40 63
		300							32 40 63

Type A with C characteristic

	Rated residual current $I_{\Delta n}$ (mA)	Rated current I_n (A)	MW#	Reference No.	Std. Pkg. (Nos.)				
	240Vac; 50...60Hz; 2 pole		4	5SU13247RC32 5SU13247RC40 5SU13247RC63 5SU14247RC32 5SU14247RC40 5SU14247RC63 5SU16247RC32 5SU16247RC40 5SU16247RC63	1/10 1/10 1/10 1/10 1/10 1/10 1/10 1/10 1/10				
	30	32 40 63							
	100	32 40 63							
	300	32 40 63							
		415Vac; 50...60Hz; 4 pole				7	5SU13447RC32 5SU13447RC40 5SU13447RC63 5SU14447RC32 5SU14447RC40 5SU14447RC63 5SU16447RC32 5SU16447RC40 5SU16447RC63	1/5 1/5 1/5 1/5 1/5 1/5 1/5 1/5 1/5	
		30							32 40 63
		100							32 40 63
		300							32 40 63

Type AC with D characteristic

	Rated residual current $I_{\Delta n}$ (mA)	Rated current I_n (A)	MW#	Reference No.	Std. Pkg. (Nos.)				
	240Vac; 50...60Hz; 2 pole		4	5SU13248RC32 5SU13248RC40 5SU13248RC63 5SU14248RC32 5SU14248RC40 5SU14248RC63 5SU16248RC32 5SU16248RC40 5SU16248RC63	1/10 1/10 1/10 1/10 1/10 1/10 1/10 1/10 1/10				
	30	32 40 63							
	100	32 40 63							
	300	32 40 63							
		415Vac; 50...60Hz; 4 pole				7	5SU13448RC32 5SU13448RC40 5SU13448RC63 5SU14448RC32 5SU14448RC40 5SU14448RC63 5SU16448RC32 5SU16448RC40 5SU16448RC63	1/5 1/5 1/5 1/5 1/5 1/5 1/5 1/5 1/5	
		30							32 40 63
		100							32 40 63
		300							32 40 63

Additional components

Auxiliary circuit switch/fault signal contact for 5SU1

Benefits

- Can be retrofitted individually
(For mounting concept and more technical details refer MCB accessories section)

Application

Indication of the miniature circuit-breaker's switching state:

- AS: ON/OFF
- FC: tripped

Design

- Min contact load: 50 mA, 24 V

Selection and ordering data

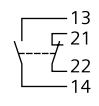
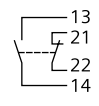
	Version	MW	Order No.	Weights 1 item kg	PS*/ P unit Items	
	Auxiliary circuit switches (AS) 	for small output 1 NO + 1NC	0.5	5ST3 010	0.050	10
	Fault signal contacts (FC) 	1NO + 1 NC	0.5	5ST3 020	0.050	10

Betagard Residual Current Devices

Betagard 5SU RCBOs

Additional components

Shunt trip/undervoltage release for 5SU1

Benefits

Shunt release

- Can be retrofitted individually (For more technical details refer MCB accessories section)
- Suitable for voltages:
110 to 415 V AC, 110 V AC
24 to 48 V AC/DC

Undervoltage releases

- Can be retrofitted individually (For more technical details refer MCB accessories section)
- Suitable for voltages:
230 V AC
110 V DC
24 V DC

Application



Shunt release

- Remove tripping of the miniature circuit-breaker

Undervoltage releases

- Applicable as remote trip in an EMERGENCY-OFF loop
- Ensures disconnection of the control circuit acc. to EN 60204
- In cases of interrupted or insufficient voltage, the undervoltage release trips the miniature circuit-breaker or prevents it from switching on.

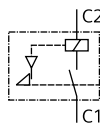
Selection and ordering data

	Rated voltage U_n		MW	Order No.	Weights 1 item kg	PS*/ P unit Items
	Shunt trips (ST)					
		110 ... 415 V AC	1	5ST3 030	0.098	1/5
		24 ... 48 V AC/DC	1	5ST3 031	0.098	1/5
	Undervoltage releases (UR)					
		230 V AC	1	5ST3 043	0.115	1/5
		24 V DC		5ST3 045	0.115	1/5

Mounting concept

Using this mounting concept, all additional 5ST3 components can be combined with residual current breaker operators of 5SU1 series:

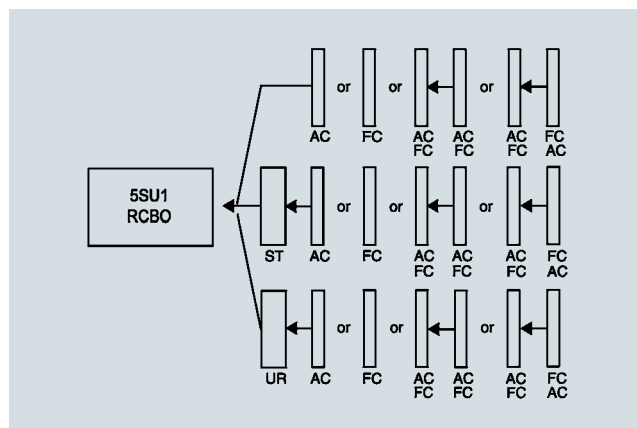

Betagard Residual Current Devices

Betagard 5SU RCBOs

Dimensions

2P-2M

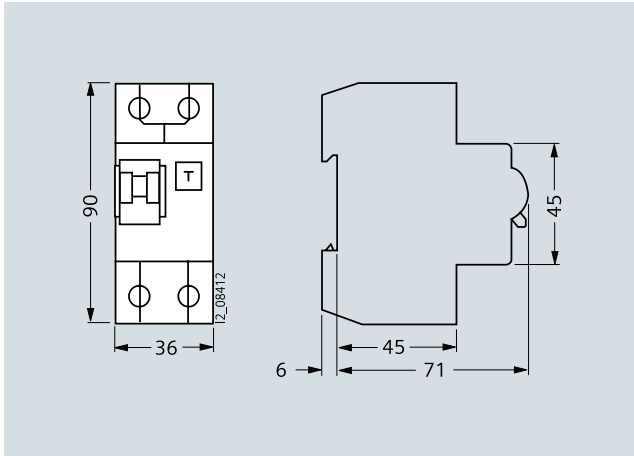

2P-4M

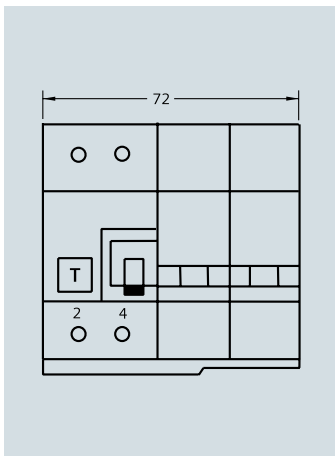

4P-7M

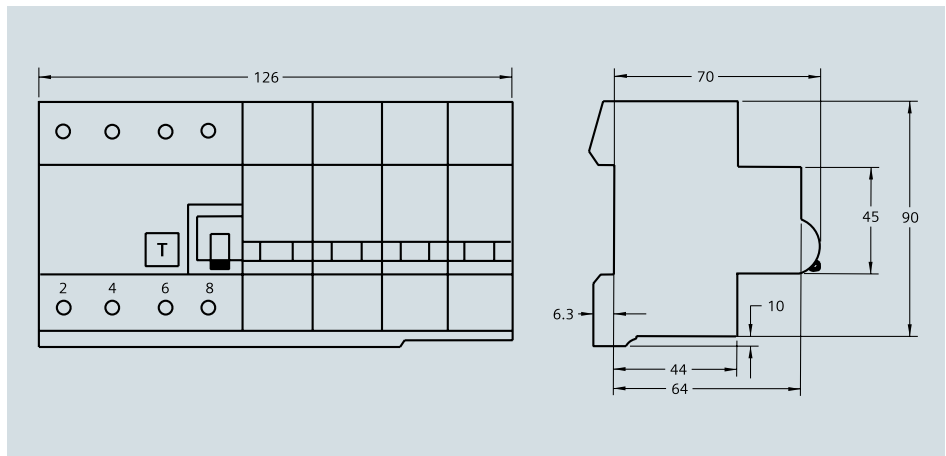

Add-on components

*Auxiliary contact /
Fault signal contact*

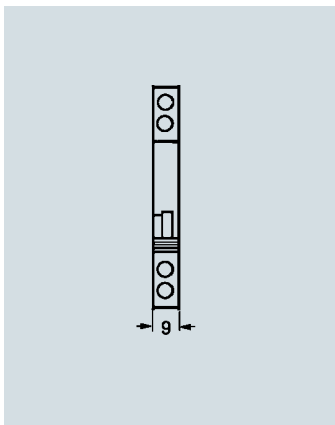

Shunt trip / undervoltage release

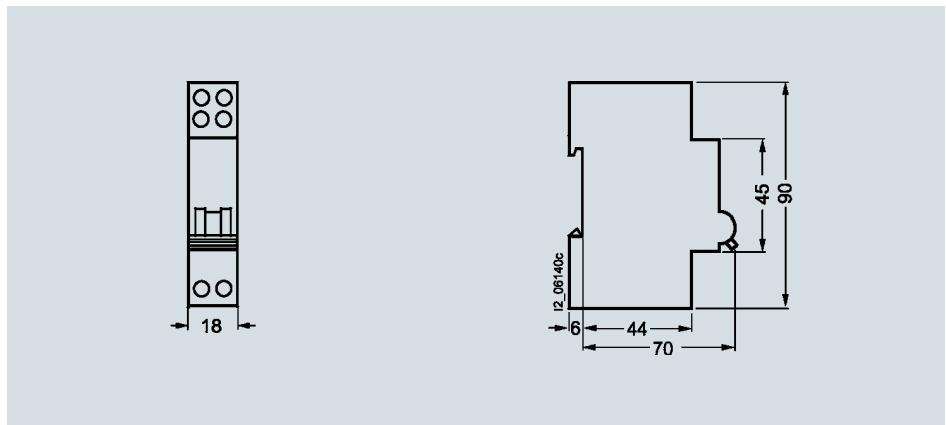

Betagard Residual Current Devices

Notes